

ADVANCES IN MICROWAVE ERROR CORRECTION TECHNIQUES

Doug Rytting
Network Measurements Division
1400 Fountaingrove Parkway
Santa Rosa, California 95401

*RF & Microwave
Measurement
Symposium
and
Exhibition*

 HEWLETT
PACKARD

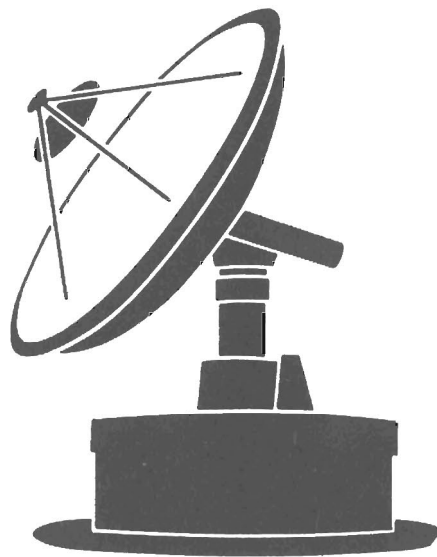



ABSTRACT

Many improvements have occurred in microwave error correction techniques the past few years. The various error sources which degrade calibration accuracy is better understood. Standards have been developed with increased accuracy and utility. New Calibration techniques have been implemented that offer improved performance with more accurate and easier to manufacture standards. These new techniques also make in-circuit calibrations more practical and traceable. Methods have also been developed to determine the post calibration accuracy of a microwave network analyzer measuring linear networks.

AUTHOR

Doug Rytting, engineering Section Manager for microwave network analyzers, HP Network Measurements Division, Santa Rosa, CA. BSEE Utah State University; MSEE Stanford University. With HP since 1966; has worked on virtually every HP high-frequency network analyzer project culminating with the new HP 8510B.

ADVANCES IN MICROWAVE ERROR CORRECTION TECHNIQUES

6201

Over the past few years there has been significant improvement and understanding of microwave error correction techniques. This paper will give an overview of these advancements.

AGENDA

**Why Error Correction
General Theory**

**Potential Problems
Improved Standards**

**Offset-Load Calibration
Non-Insertable/Transitional Calibration
TRL Calibration Method**

Accuracy of Error Correction

6202

The paper is divided into four major sections. The first section covers the basic theory and present methods used for error correction. The second section deals with the potential problems of error correction and improved standards that will result in better performance. Three new calibration methods are discussed in the third section. The last section deals with the question of how accurate is my system when measuring my particular device under test.

WHY ERROR CORRECTION

6203

WHY ERROR CORRECTION

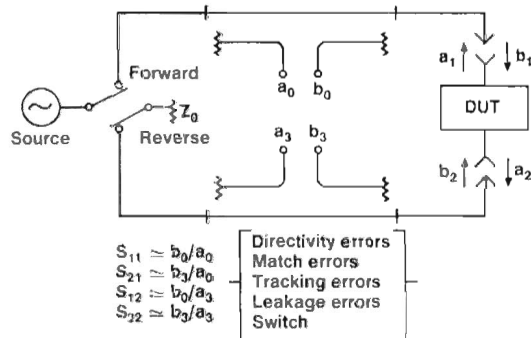

6204

This is a typical block diagram of a network analyzer used to measure small signal s-parameters. The primary microwave errors are caused by the imperfections in the microwave hardware. The system directivity error is due primarily to the directivity error of the reflection coupler. The system match errors are due to the port match errors at the test ports. The tracking errors are primarily the tracking error of the couplers and the tracking error of the down converter. There are leakage errors between the down converters through the local oscillator path, as well as leakage errors of the switch and between test ports. The switch also has repeatability error that will reduce system performance.

WHY ERROR CORRECTION

LET'S MEASURE AN AIRLINE (APC-7)

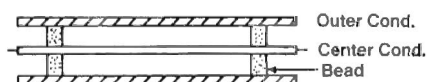

1. With response only calibration.
2. With TRL Calibration (Full Cal)

6205

To see the improvements offered by error correction lets compare the measurement results before and after error correction when measuring a beaded airline. The two test cases will be with a response only calibration, which will not remove the port match errors, and a full two port calibration which will remove the port match errors.

WHY ERROR CORRECTION

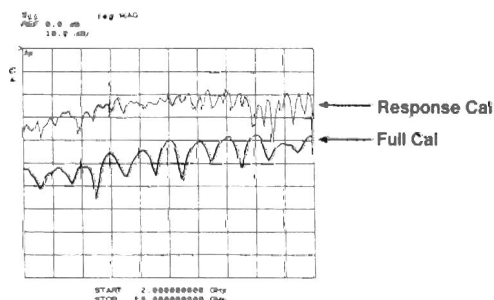

6206

There is a twenty dB improvement in the reflection measurements when the port match errors are removed.

WHY ERROR CORRECTION

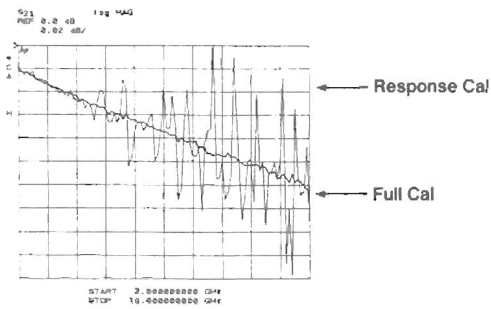

6207

The transmission tracking errors are greatly improved with error correction. It should be pointed out that the response calibration errors are only a tenth dB which means the uncorrected return loss at both test ports must be at least 20 dB.

WHY ERROR CORRECTION

Can also remove errors due to:

1. Adapters
2. Cables
3. Fixtures

6208

Error correction is performed by placing known standards at the test ports which allows the errors of the system to be characterized. Since this calibration is at the measurement plane, the errors caused by cables, adapters and fixturing can be greatly reduced.

GENERAL THEORY

6209

GENERAL THEORY

One-port error correction model

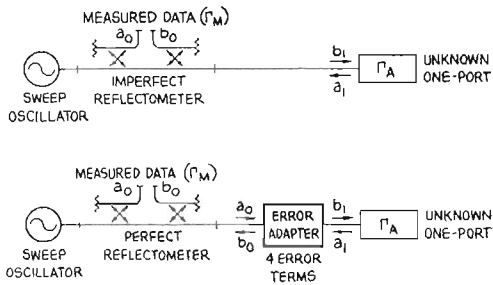

6210

For the one-port case let's assume that the reflectometer is perfect. All the errors of the system can then be modeled by a two-port error adapter between the measurement plane and the perfect reflectometer. It requires 4 error terms to describe all the errors of the system if we wish to make power and s-parameter measurements.

GENERAL THEORY

One-port error correction flow-graph & solution

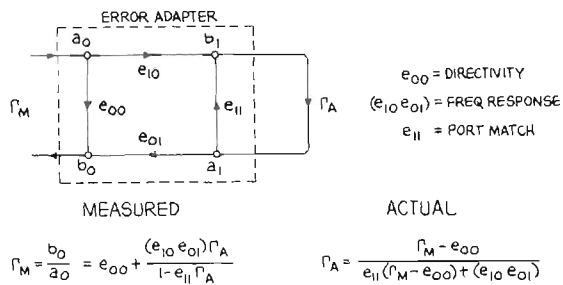

6211

From the flowgraph we can solve for the measured reflection coefficient in terms of the actual device under test. For ratio measurements we only need to know three error terms. The resulting equation can be inverted to solve for the actual reflection coefficient, if we know what the three error terms are.

GENERAL THEORY

One-port error correction calibration

$$\Gamma_M = e_{00} + \frac{(e_{10} e_{01}) \Gamma_A}{1 - e_{11} \Gamma_A} \equiv \frac{a \Gamma_A + b}{c \Gamma_A + 1}$$

$$a = e_{10} e_{01} - e_{00} e_{11}$$

$$b = e_{00}$$

$$c = -e_{11}$$

$$\Gamma_A a + b - \Gamma_A \Gamma_M c = \Gamma_M$$

- WITH 3 DIFFERENT KNOWN Γ_A , MEASURE THE RESULTANT 3 Γ_M
- THIS YIELDS 3 EQUATIONS TO SOLVE FOR a, b & c

$$\Gamma_{A1} a + b - \Gamma_{A1} \Gamma_{M1} c = \Gamma_{M1}$$

$$\Gamma_{A2} a + b - \Gamma_{A2} \Gamma_{M2} c = \Gamma_{M2}$$

$$\Gamma_{A3} a + b - \Gamma_{A3} \Gamma_{M3} c = \Gamma_{M3}$$

6212

To solve for the three error terms, let's change variables so that the equations are transformed to the bilinear form. This allows a linear equation to be written in terms of the actual and measured reflection coefficient and the three error terms. If there are three known standards and the measured results of those three standards, there then exists three equations and three unknowns that can be solved for the error terms.

GENERAL THEORY

Typical known standards are:

- Open
- Short
- Load (fixed)
- Load (sliding)
- Offset short

6213

Three standards are required to calibrate the system. Any one-port standard can theoretically be used as long as they are not the same value. It is important that the reflection coefficient of the standards be widely separated on the smith chart. And that they can be easily manufactured and the reflection coefficient of the standards accurately modeled or measured. This has typically led to the use of opens, shorts, and loads as the primary standards used for calibration.

GENERAL THEORY SLIDING LOAD

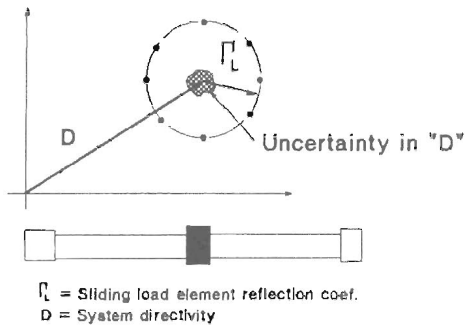

6214

One interesting standard is the sliding load. The sliding load consists of a sliding load element whose reflection coefficient does not change as the element is slid. This generates a circular locus of data points centered around the directivity error. A circle fitting algorithm is used to determine the center of the circle and thus solve for the directivity error.

GENERAL THEORY Typical One-port Calibration (APC-7)

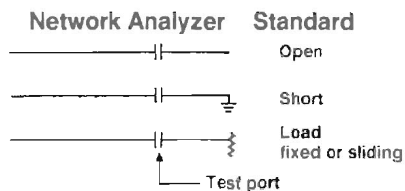

6215

The typical calibration routine is to connect the three standards consisting of an open, short and either a fixed load or sliding load. At low frequencies a sliding load is impractical to manufacture and fixed loads are the only realistic choice.

GENERAL THEORY

Two-port error correction model

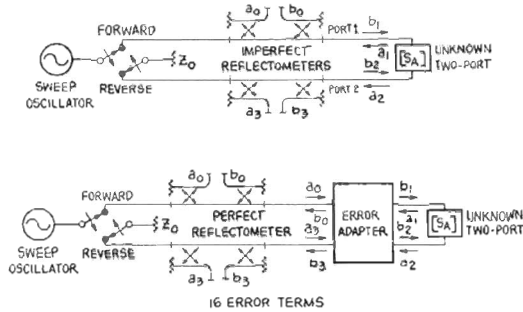

6216

The two-port calibration model follows the same line of reasoning as the one-port case. However, in the two-port case the error adapter is a four port network.

GENERAL THEORY

Two-port error correction model forward & reverse

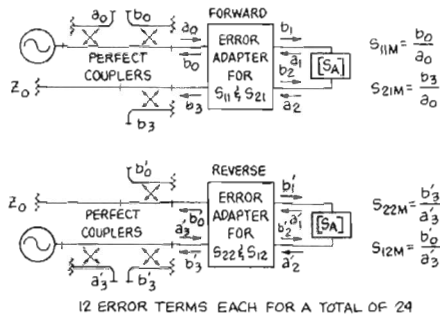

6217

To remove the effect of the different impedances caused by the switch changing states, the model can be separated into a forward and reverse form where the source and termination switch ends. Twenty four error terms are required to fully characterize this system.

GENERAL THEORY

Two-port signal flow

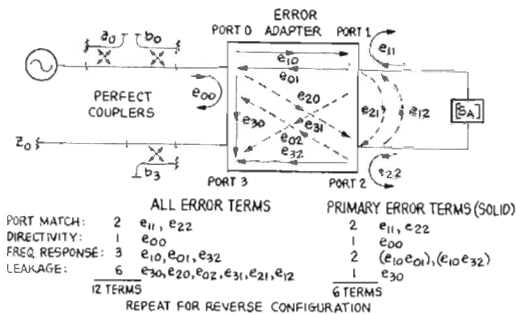

6218

The model can be simplified if certain leakage error terms are small enough to be neglected. Also when making ratio measurements the frequency error terms combine into two terms. This results in six error terms in the forward and six terms in the reverse direction for a total of twelve error terms.

GENERAL THEORY

Two-port flow graph

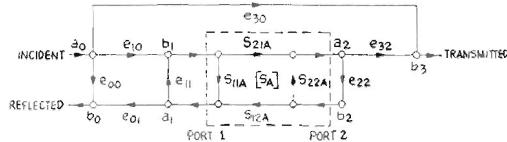

ERROR TERMS

PORT 1 MATCH: e_{11} TRANS FREQ RESPONSE: $(e_{10}e_{32})$
 PORT 2 MATCH: e_{22} DIRECTIVITY: e_{00}
 REFL FREQ RESPONSE $(e_{10}e_{01})$ LEAKAGE: e_{30}

$$\bullet S_{11M} = \frac{b_0}{a_0} = e_{00} + (e_{10}e_{01}) \frac{S_{11A} - e_{22} \text{DET} [S_A]}{1 - e_{11}S_{11A} - e_{22}S_{22A} + e_{11}e_{22} \text{DET} [S_A]}$$

$$\bullet S_{21M} = \frac{b_2}{a_0} = e_{30} + (e_{10}e_{32}) \frac{S_{21A}}{1 - e_{11}S_{11A} - e_{22}S_{22A} + e_{11}e_{22} \text{DET} [S_A]}$$

$$\text{DET} [S_A] = S_{11A}S_{22A} - S_{21A}S_{12A}$$

6219

The resultant flow graph and equations are a function of the six error terms and the four measured s-parameters of the device under test. There is a similar set of equations in the reverse direction.

GENERAL THEORY

Two-port solution

FORWARD: S_{11M} = FUNCTION OF $(S_{11A}, S_{21A}, S_{12A}, S_{22A}, e_{10}, e_{01}, e_{11}, e_{22}, e_{30}, e_{32})$ (E10)
 S_{21M} = FUNCTION OF $(S_{11A}, S_{21A}, S_{12A}, S_{22A}, e_{10}, e_{01}, e_{11}, e_{22}, e_{30}, e_{32})$ (E11)
 REVERSE: S_{21M} = FUNCTION OF $(S_{11A}, S_{21A}, S_{12A}, S_{22A}, e_{10}, e_{01}, e_{11}, e_{22}, e_{30}, e_{32})$ (E12)
 S_{11M} = FUNCTION OF $(S_{11A}, S_{21A}, S_{12A}, S_{22A}, e_{10}, e_{01}, e_{11}, e_{22}, e_{30}, e_{32})$ (E13)

- WE KNOW THE ERROR TERMS BY CALIBRATION
- THEN WE HAVE 4 EQUATIONS IN 4 UNKNOWN
- SOLVE SIMULTANEOUSLY TO YIELD $S_{11A}, S_{21A}, S_{12A}$ & S_{22A}

$$\bullet S_{11M} = \frac{b_0}{a_0} = e_{00} + (e_{10}e_{01}) \frac{S_{11A} - e_{22} \text{DET} [S_A]}{1 - e_{11}S_{11A} - e_{22}S_{22A} + e_{11}e_{22} \text{DET} [S_A]}$$

$$\bullet S_{21M} = \frac{b_2}{a_0} = e_{30} + (e_{10}e_{32}) \frac{S_{21A}}{1 - e_{11}S_{11A} - e_{22}S_{22A} + e_{11}e_{22} \text{DET} [S_A]}$$

$$\bullet S_{12M} = \frac{b_1}{a_2} = e_{31} + (e_{10}e_{31}) \frac{S_{12A}}{1 - e_{11}S_{11A} - e_{22}S_{22A} + e_{11}e_{22} \text{DET} [S_A]}$$

$$\bullet S_{22M} = \frac{b_3}{a_2} = e_{00} + (e_{10}e_{01}) \frac{S_{22A} - e_{11} \text{DET} [S_A]}{1 - e_{11}S_{11A} - e_{22}S_{22A} + e_{11}e_{22} \text{DET} [S_A]}$$

$$\bullet \text{DET} [S_A] = S_{11A}S_{22A} - S_{21A}S_{12A}$$

6220

If the values of the twelve error terms, and the measured s-parameters of the device under test are known, then there is a solution for the actual s-parameters. These four non-linear equations can be solved in closed form and are easy to evaluate on a computer.

GENERAL THEORY

Two-port calibration

STEP 1: CALIBRATE PORT 1 USING ONE-PORT PROCEDURE

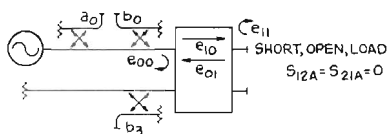

$$\bullet S_{11M} = \frac{b_0}{a_0} = e_{00} + (e_{10}e_{01}) \frac{S_{11A} - e_{22} \text{DET} [S_A]}{1 - e_{11}S_{11A} - e_{22}S_{22A} + e_{11}e_{22} \text{DET} [S_A]} \rightarrow e_{00} + (e_{10}e_{01}) \frac{S_{11A}}{1 - e_{11}S_{11A}}$$

• SOLVE FOR: e_{00}, e_{11} & $(e_{10}e_{01})$

6221

The first step in solving for the error terms is to calibrate port one using the one-port calibration method described earlier. This will solve for the three error terms describing the system directivity, reflection frequency response, and port 1 match.

GENERAL THEORY

Two-port calibration

STEP 2: CONNECT Z_0 TERMINATIONS TO PORTS 1 & 2

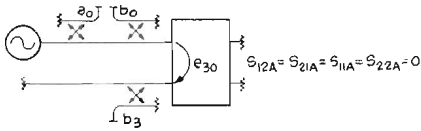

- $S_{21M} = \frac{b_3}{a_0} = e_{30} + (e_{10} e_{32}) \frac{S_{21A}}{1 - e_{11} S_{11A} - e_{22} S_{22A} + e_{11} e_{22} \text{DET} [S_A]} \rightarrow e_{30}$
- $e_{30} = S_{21M}$

6222

GENERAL THEORY

Two-port calibration

STEP 3: CONNECT PORTS 1 & 2 TOGETHER

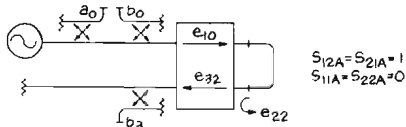

- $S_{11M} = \frac{b_0}{a_0} \rightarrow e_{00} + (e_{10} e_{01}) \frac{e_{22}}{1 - e_{11} e_{22}}$
 - WE KNOW e_{00}, e_{11} & $(e_{10} e_{01}) \therefore$ **SOLVE FOR e_{22}**
 - $S_{21M} = \frac{b_3}{a_0} \rightarrow e_{30} + (e_{10} e_{32}) \frac{1}{1 - e_{11} e_{22}}$
 - WE KNOW e_{30}, e_{11} & $e_{22} \therefore$ **SOLVE FOR $(e_{10} e_{32})$**
- REPEAT FOR REVERSE CONFIGURATION

6223

GENERAL THEORY

Typical Two-port Calibrations

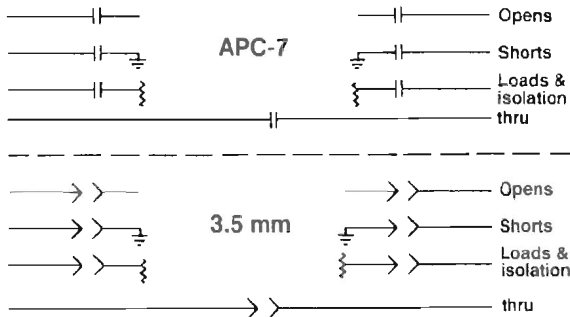

6224

The leakage error can be determined by connecting loads to the two test ports and measuring the leakage directly.

With the two ports connected together, the calibrated one-port can be used to measure the port match of the second port. Also the transmission frequency response can be calculated from the thru measurement since all the other error terms are known. The total calibration procedure needs to be repeated for the reverse direction.

The typical calibration sequence is shown for both the APC-7 sexless connector and also for the sexed 3.5 mm connector environments. Notice that for the sexed connectors both male and female standards are required.

POTENTIAL PROBLEMS

6225

POTENTIAL PROBLEMS

- **Poor standards or Models**
- 1. **Mechanical Tolerances**
- 2. **Skin loss of airlines**
- 3. **Stability of sliding loads**
- 4. **Knowing phase of opens**
- 5. **Slots in female connector**
- 6. **Gaps at connector interfaces**
- 7. **Connector repeatability**
- 8. **Can't easily realize standards**

6226

POTENTIAL PROBLEMS

MECHANICAL TOLERANCES (7 mm example)

O.D. Tolerance Center Cond.	I.D. Tolerance Outer Cond.	Mechanical Zo	Mechanical Return Loss
± 20 μ in	± 40 μ in	50.02 Ω	-74 dB
± 35 μ in	± 80 μ in	50.04 Ω	-69 dB
± 70 μ in	± 160 μ in	50.07 Ω	-63 dB
± 150 μ in	± 250 μ in	50.13 Ω	-58 dB

Additional errors due to concentricity & eccentricity.

6227

If the standards were perfect, the only errors would be due to the network analyzer. Unfortunately there are numerous errors that potentially can cause difficulties. Many of these are due to mechanical issues involving tight tolerances. Others are due to modeling errors. The basic definition of the connector interface is also an issue. For example, how do you model slots and gaps in connectors. If there is not a clean definition on the connector interface it is very difficult to cascade devices s-parameters accurately. Skin loss also affects the characteristic impedance of the airline. And connector repeatability determines an absolute performance floor.

This table illustrates the tight tolerances required to achieve high performance for airlines. In addition to the errors listed in the table there are additional errors caused by concentricity and eccentricity.

POTENTIAL PROBLEMS

Return loss of airline due to skin loss

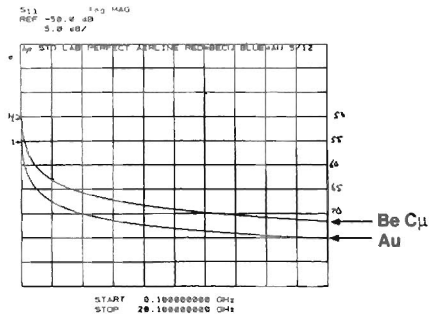

6228

Skin loss in non perfect conductors cause the characteristic impedance to change. Pure gold 7 mm airlines at 100 Mhz have a theoretical return loss limit of 55 dB.

POTENTIAL PROBLEMS

Stability of sliding load
Element return loss \cong 40 dB

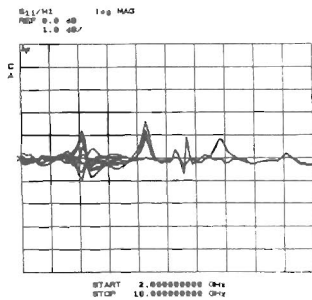

6229

The reflection coefficient of the sliding element of a sliding load should not change as it is slid. But small instabilities do exist and cause some error.

POTENTIAL PROBLEMS

KNOWING PHASE OF OPEN

Phase Error of Open	Effective Port Match
5 deg	- 27 dB
2 deg	- 35 dB
1 deg	- 41 dB
.5 deg	- 47 dB
.2 deg	- 55 dB

Return Loss

6230

Modeling the open circuit capacitance is difficult. This capacitance directly impacts the open circuit phase error which in turn directly determines the effective port match.

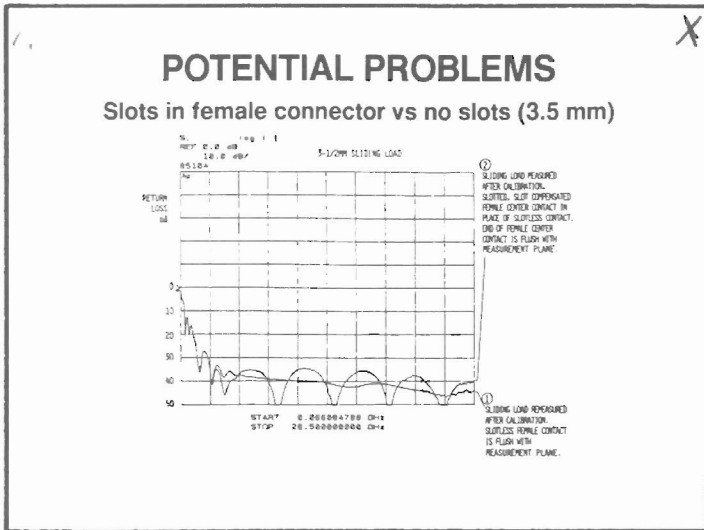

6231

Slots in female center conductors are very difficult to model. There are no set manufacturing standards and the impedance at the slot area will change depending on the male pin size. Mechanically measuring and providing traceability of slots is very difficult. This plot shows a comparison between slotless and slotted contacts. Notice a 6 dB error in measuring the sliding load element caused by the slots.

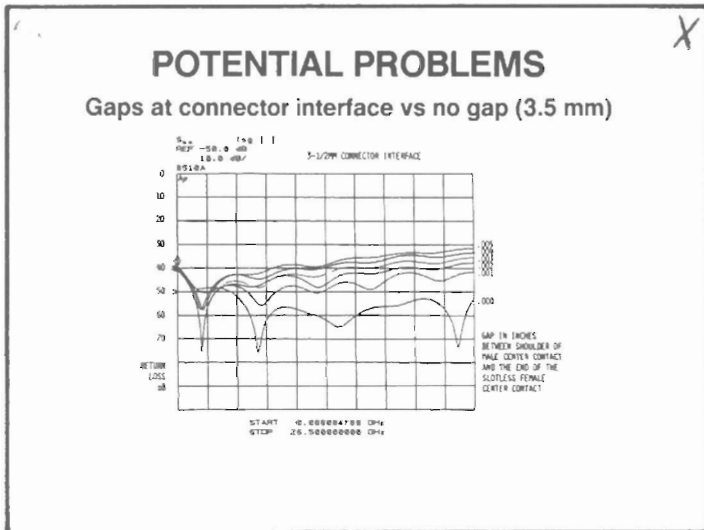

6232

Gaps at the connector interface add an inductive component. A .001 inch gap in 3.5 mm connectors can cause an error only 40 dB down.

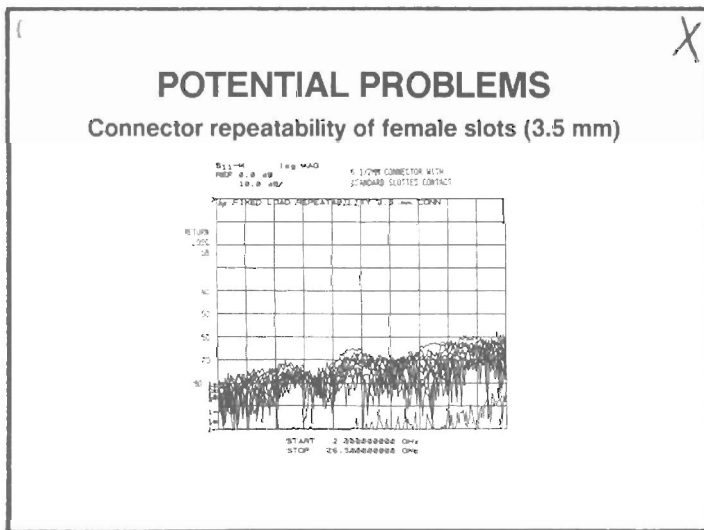

6233

Connector repeatability determines the ultimate performance limit. Notice that the best performance for 3.5 mm connectors has a return loss of 60 dB. The beat pattern is caused by rotating the connector thus changing the contact fingers position.

POTENTIAL PROBLEMS

Can't easily realize standards:

Substrate open

Substrate short

Substrate load

Sliding load at 75-110 GHz

6234

When making calibration standards for microstrip, monolithic, or other substrate transmission lines, it is very difficult to realize some very common standards. Also at high frequencies the mechanical tolerances push the limit on practicality.

IMPROVED STANDARDS

6235

Some of the calibration problems can be reduced by designing new standards.

IMPROVED STANDARDS CENTER CONDUCTOR FLUSH

(Within 0.0001 inch)

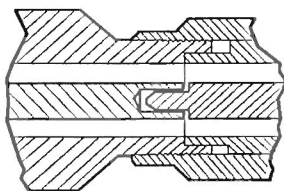

Standard

Test port

- * Minimizes gap
- * Provides consistent reference plane

5911

The major improvement is to define standards that are flush with no gaps or slots. The resultant simple mechanical structure is easy to trace to primary national mechanical standards and the measurement system calibrated with these standards can be certified.

IMPROVED STANDARDS

SLOTLESS COAXIAL STANDARDS

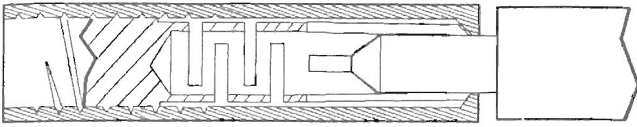

- * Conductor ratio = constant
- * Constant impedance

5762A

The slotless contact is an inner contact that does not change the mechanical outer detail as connection is made. It is a very high life low impedance contact.

IMPROVED STANDARDS

Slotless female contact inductance short with contact compared to "ideal" short

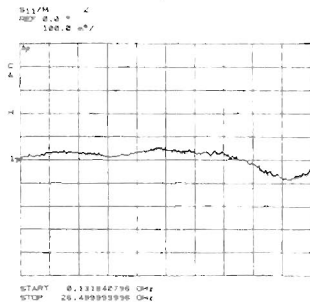

6238

The slotless female contact, placed in a short, is compared to an ideal short. The phase shift between the two is less than .1 degrees across the frequency band, indicating very low contact inductance.

IMPROVED STANDARDS

Slotless female contact repeatability (3.5 mm)

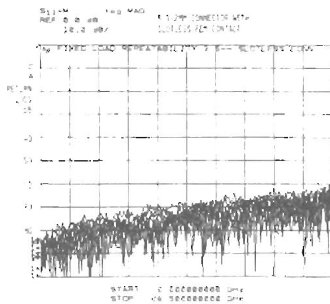

6239

The slotless contact has a little better repeatability due to the female fingers not moving as the connector is rotated.

IMPROVED STANDARDS

One-piece opens

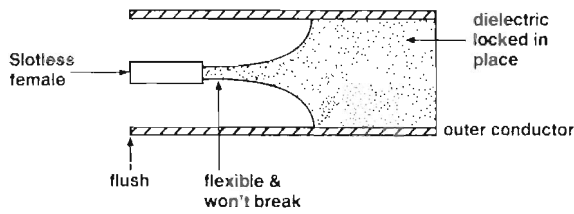

6240

The open is a one piece slotless female contact set flush to the plane of the outer conductor. The open is much more repeatable and reliable than before.

IMPROVED STANDARDS

PULL-BACK SLIDING LOAD

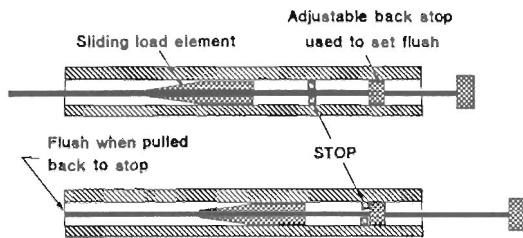

- * Better connection
- * Easier to use

5824A

The sliding load also incorporates the slotless and flush contact. Plus the ability to easily connect the load by pushing the center conductor forward to make contact. Then the back stop allows the center conductor to return to the flush position after connection.

IMPROVED STANDARDS

Broad-band load (7 mm)

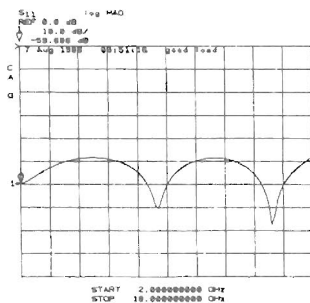

6241

Fixed broad band loads have been developed that allow quick and easy calibration if the ultimate in performance is not required. Return losses in excess of 40 dB can be achieved.

OFFSET-LOAD CALIBRATION

6242

Fixed loads and sliding loads are the typical terminations used to solve for the directivity error of the system. Another technique will be described in this section using a precision airline of known physical dimensions and a repeatable fixed termination.

OFFSET-LOAD CAL

Using a short precision airline & termination to determine directivity error (D)

THRU CONNECTION

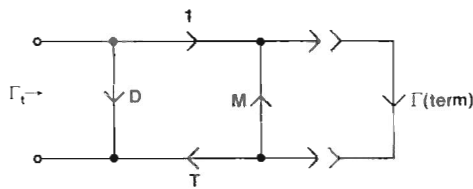

$$(1) \Gamma_i \cong D + T\Gamma$$

6243A

The first step in the offset-load calibration method is to connect a good fixed termination to the test port and measure the resultant reflection coefficient.

OFFSET-LOAD CAL

DELAY CONNECTION

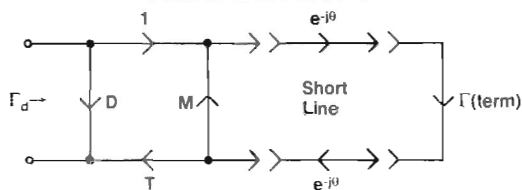

$$(2) \Gamma_d \cong D + \Gamma e^{-2j\theta}$$

6243B

The next step is to connect a precision airline, in cascade with the termination, to the test port.

OFFSET-LOAD CAL Solving for directivity

Using Eq (1) & (2)

$$(3) \quad D = \frac{\Gamma_d - e^{-2j\theta} \Gamma_t}{1 - e^{-2j\theta}}$$

- Must know length of airline which determines θ .
- Airline S_{11} & S_{22} are assumed perfect (Z_0 of line is reference)

6244

Using the above two measurements we can solve for the directivity. The value of the loads reflection coefficient is not required in the solution. The impedance of the airline becomes the reference impedance of the system.

OFFSET-LOAD CAL Graphical Solution

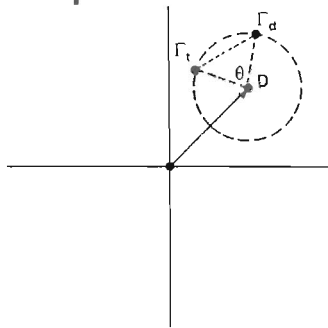

6245

Graphically the solution can be represented by knowing two points on a circle and the angle between them. These three conditions are sufficient to solve for the center of the circle. The similarities between the sliding load method and offset load method can easily be seen.

OFFSET-LOAD CAL Error Analysis

$$(4) \quad \Gamma_t = D + \frac{T\Gamma}{1 - M\Gamma}$$

$$(5) \quad \Gamma_d = D + \frac{T\Gamma e^{-2j(\theta+\epsilon)}}{1 - M\Gamma e^{-2j(\theta+\epsilon)}}$$

θ = Actual phase shift

ϵ = Error in phase

Substituting (4) & (5) into (3)

$$D_\epsilon \approx D - T\Gamma e^{-2j\theta} \frac{1 - e^{-2j\epsilon}}{1 - e^{2j\theta}} - TM\Gamma^2 e^{-2j\theta}$$

A (length error) B (mismatch error)

$$D_\epsilon \triangleq \text{actual } D + \text{errors}$$

6246

Using a more complete analysis shows that there are second order effects that will potentially reduce the accuracy. One error is due primarily to not knowing the precise length of the airline. The other error is due to the reflection coefficient of the fixed load. These errors are typically very small as will be shown in the next slide. The length of the airline should be one quarter wavelength at the center of the band and typically should not be used over more than a 9 to 1 frequency span.

OFFSET-LOAD CAL Typical errors at 100 GHz

If: $|T| \cong 1$
 $|\Gamma| \cong .02$ (-34 dB)
 $|M| \cong .02$ (-34 dB)
 $\theta = 90^\circ$ ($1/4\lambda$)
 $\epsilon = .3^\circ$ phase error for a .1 mil length error at 100 GHz

Worst case errors:

$$D_\epsilon = D + \underset{\substack{\text{A} \\ \downarrow \\ -80 \text{ dB} \\ \text{length error}}}{.001} + \underset{\substack{\text{B} \\ \downarrow \\ -102 \text{ dB} \\ \text{mismatch error}}}{8 \times 10^{-6}}$$

$D_\epsilon \triangleq$ actual D + errors

6247

The errors at 100 GHz are in the order of 80 to 100 dB down (if the length error is less than 100 millionths of an inch and the fixed load reflection coefficient is greater than 34 dB). This performance can easily be achieved below 100 GHz.

TYPICAL ONE-PORT OFFSET-LOAD CAL (7 mm)

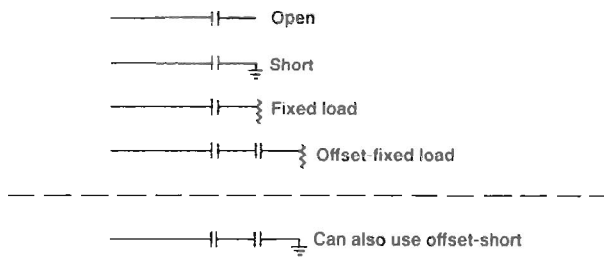

6248

The typical calibration sequence consists of using an open, short, load, and offset load. The precision airline and a short can be used in place of the open in coax systems and is required in waveguide applications.

Offset-load Cal (7 mm) measuring 40 dB return loss load

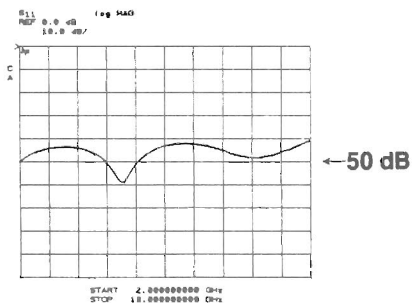

6249

The offset load cal method provides excellent results when measuring low reflection devices. The measurement of the 40 dB return loss load is calibrated to the reference impedance of the precision airline.

Sliding load Cal (7 mm) measuring 40 dB return loss load

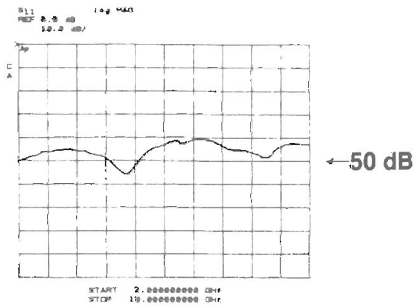

6250

The same load measured with a high quality sliding load calibration shows a little more ripple and is not quite as accurate. It is more difficult to manufacture a long sliding load with the same accuracy as the short precision airline. Also the slide stability and center conductor droop and other errors in the sliding load are not present in the offset load calibration method.

NON-INSERTABLE & TRANSITIONAL CALIBRATION

6251

NON-INSERTABLE & TRANSITIONAL CALIBRATION

Non-insertable device
(3.5f, 3.5f)

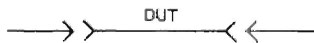

Transitional device
(3.5f, Nf)

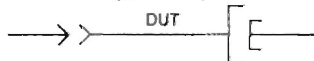

We can calibrate for reflection
but cannot connect test ports for
transmission calibration.

6252

There are many times when you want to measure a device with female or male connectors on both ends. The problem is that you can not connect the two test ports together for the transmission calibration. The same problem exists if the device has different connectors at both ends, like type N and waveguide.

NON-INSERTABLE & TRANSITIONAL CALIBRATION

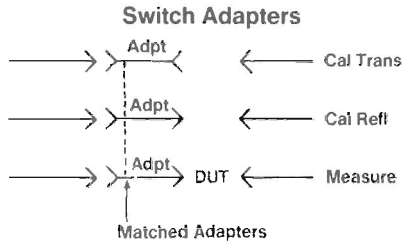

6253

One method that can be used, when there are connectors of the same family and same sex, is to swap matched adapters. The process is to first calibrate the transmission path with an adapter. Then switch the adapter to the correct sex for the desired test port configuration, and calibrate for reflection. The accuracy will be as good as the adapters are matched.

NON-INSERTABLE & TRANSITIONAL CALIBRATION

Typical Switched Adapter Cal (3.5 mm)

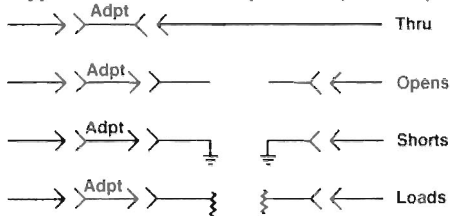

Accuracy reduced by the errors between the matched adapters

6254

The typical switched adapter calibration is illustrated. Again, the best time to switch the adapters is between the thru and reflection calibration steps.

NON-INSERTABLE & TRANSITIONAL CALIBRATION

Adapter Removal Cal

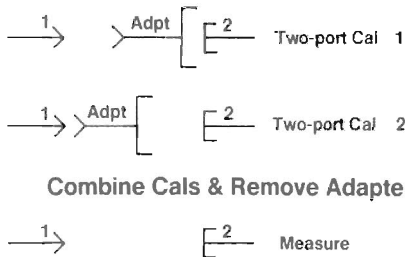

Use redundant data to improve Cal.

6255

In the case when there are different connector families at each end of the device, the switched adapter approach will not work. Also if higher accuracy is desired, than provided by the swapped adapter approach, a different calibration method is required. The mathematical method of removing the adapter is an excellent way to achieve both of the above objectives. The process is to first do a two-port calibration at test port 1 then do a two-port calibration at test port 2. These two calibrations can then be combined to remove the adapter and provide a complete non insertable calibration. The redundant data gathered by this method is used to improve the final calibration results.

NON-INSERTABLE & TRANSITIONAL CALIBRATION

Typical Adapter Removal Cal (3.5 mm to Type-N)

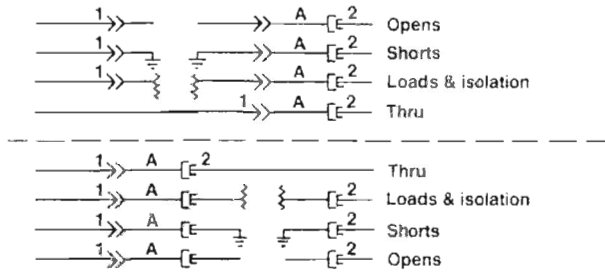

6256

The typical calibration sequence used to remove the adapter is simplified by doing the two thru measurements sequentially.

NON-INSERTABLE & TRANSITIONAL CAL

Comparing Adapter Removal Cal (APC-7) to Standard Cal (APC-7)

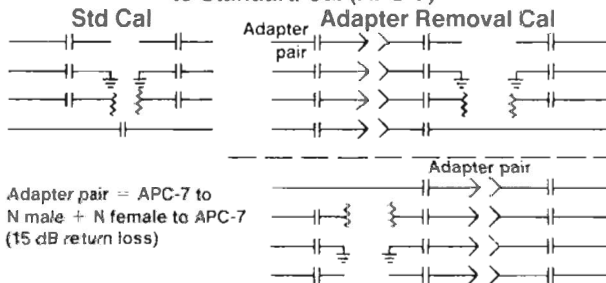

6257

This calibration sequence was used to compare a standard APC-7 calibration to the adapter removal calibration method. An APC-7 to type N back to back adapter was used for the experiment. Both calibrations were completed and then a device was measured and the results compared.

NON-INSERTABLE & TRANSITIONAL CAL

Comparing adapter removal cal (APC-7) to standard cal (APC-7) measuring 10 cm airline

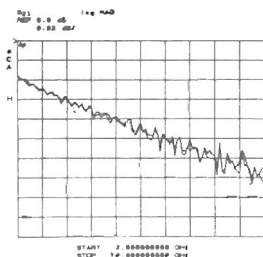

6258

The device measured was a 10 cm long beaded airline. The calibration method used a fixed load. The transmission results compare very well. Even the errors caused by the fixed load calibration standard are repeated within .01 dB.

NON-INSERTABLE & TRANSITIONAL CAL

Comparing adapter removal cal (APC-7) to standard cal (APC-7) measuring 10 cm airline

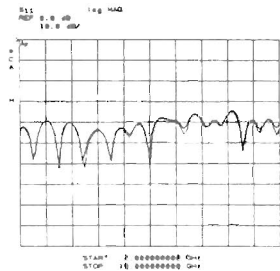

6259

The result for reflection measurements show agreement between measurements that has a residual error over 50 dB down.

TRL CALIBRATION METHOD

6260

The TRL calibration method requires three standards. These are a Thru connection, a high Reflection connected to each port, and a Line connected between the test ports. Less information is required about the standards using this calibration method than with the traditional calibration approaches.

TRL CALIBRATION METHOD

Reasons for using

1. Less known standards required.
2. Standards are more physically realizable.
3. Primary standard simpler & more accurate.
4. Very applicable to μ -ckt measurements.
5. Good for primary cal. in precision meas.
6. Nice cal method for non-insertable devices.

6261

The TRL calibration method offers both simplicity as well as accuracy. The capability of making calibrations in unusual transmission line environments is also practical.

TRL CALIBRATION METHOD

System model

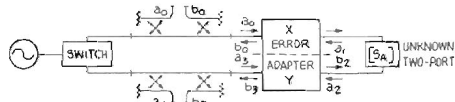

ASSUME: LEAKAGE ERROR TERMS CAN BE MEASURED BY STEP 2 OF THE STANDARD PROCEDURE. SWITCH ERRORS CAN BE 'RATIOED' OUT BY USING FOUR MEASUREMENT PORTS.

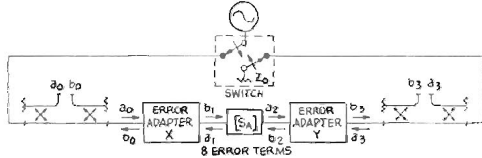

6262

The two-port model is the same as used in the standard calibration approach. The leakage is measured the same way by using loads to isolate the ports. The four port adapter is then reduced to two cascading two ports with the device under test in between.

TRL CALIBRATION METHOD

Flow or graph

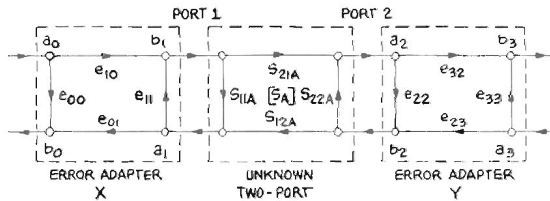

Cascade parameters

$$\begin{bmatrix} b_0 \\ a_0 \end{bmatrix} = [T_X] \begin{bmatrix} a_1 \\ b_1 \end{bmatrix}, \quad \begin{bmatrix} a_2 \\ b_2 \end{bmatrix} = [T_A] \begin{bmatrix} a_3 \\ b_3 \end{bmatrix}, \quad \begin{bmatrix} b_2 \\ a_2 \end{bmatrix} = [T_Y] \begin{bmatrix} a_3 \\ b_3 \end{bmatrix}$$

$$\therefore [T_M] = [T_X] [T_A] [T_Y]$$

6263

The resultant flow graph is best solved by using the cascading t-parameters. This results in a much simpler mathematical treatment.

TRL CALIBRATION METHOD

Calibration steps

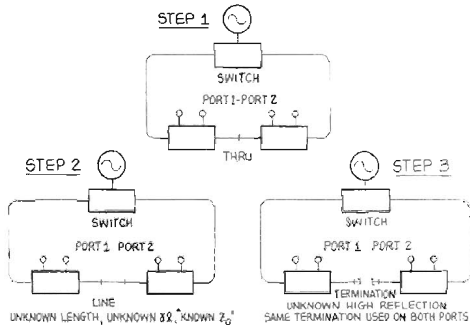

6264

The calibration steps first consist of the thru connection. Then connect a line of unknown propagation constant but known Z_0 . And the last step is to connect an unknown high reflection to each of the test ports. The primary constraints are that the system impedance is equal to the characteristic impedance of the line, and the reflect standard needs to be the same on both ports.

TRL CALIBRATION METHOD

Calibration

STEP 1
THRU CONNECTION

$$[T_{AT}] = \begin{bmatrix} 1 & 0 \\ 0 & 1 \end{bmatrix}$$

$$[T_{MT}] = [T_X] [T_Y]$$

STEP 2
AIRLINE DELAY CONNECTION

$$[T_{AD}] = \begin{bmatrix} e^{-\delta \ell} & 0 \\ 0 & e^{\delta \ell} \end{bmatrix}$$

$$[T_{MD}] = [T_X] [T_{AD}] [T_Y]$$

THE ABOVE TWO MATRIX EQUATIONS
CAN BE SOLVED FOR :

$$\delta \ell, e_{00}, e_{33}, \frac{(e_{10} e_{01})}{e_{11}} \text{ \& } \frac{(e_{23} e_{32})}{e_{22}}$$

6265

The data gathered from the thru and line connections provide enough information to calculate the lines propagation constant, the directivity, and the ratio of the reflection frequency response to port match.

TRL CALIBRATION METHOD

Calibration

STEP 3: SOLVE FOR e_{11} AND e_{22} USING HIGH REFLECTION

UNKNOWN REFLECTION
(Γ_A) ON PORT 1

$$\Gamma_{MX} = e_{00} + \frac{(e_{10} e_{01}) \Gamma_A}{1 - e_{11} \Gamma_A}$$

SOLVE FOR Γ_A
IN TERMS OF e_{11}

THRU

$$\Gamma_{MI} = e_{00} + \frac{(e_{10} e_{01}) e_{22}}{1 - e_{11} e_{22}}$$

SOLVE FOR e_{11}
IN TERMS OF e_{22}

UNKNOWN REFLECTION
(Γ_A) ON PORT 2

$$\Gamma_{MY} = e_{33} + \frac{(e_{23} e_{32}) \Gamma_A}{1 - e_{22} \Gamma_A}$$

SOLVE FOR Γ_A
IN TERMS OF e_{22}

THE ABOVE THREE EQUATIONS SOLVED FOR :

$$\Gamma_A, e_{11}, e_{22}, e_{10} e_{01}, e_{23} e_{32}$$

USE STANDARD CALIBRATION PROCEDURE STEP 3 TO SOLVE :

$$(e_{10} e_{32}) \text{ \& } (e_{23} e_{01})$$

6266

The unknown reflection on port 1 and port 2 along with a reflection measurement of the thru connection provides the additional data required to solve for the unknown reflection coefficient of the high reflection standard, and to separate the frequency to port match ratio. The transmission calibration is the same as used in the standard calibration method.

TRL CALIBRATION METHOD

Calc Z_0 of unknown airline

If no shunt losses (airline)

$$Z_0 = \frac{\gamma \ell}{j\omega C \ell}$$

We calculated $\gamma \ell$

Need only know $C \ell$

6267

If the line is an airline with no shunt loss, then the Z_0 of the airline can be calculated from the calculated propagation constant and measured mechanical dimensions of the airline. This approach will not work where there is shunt loss as in the case of a microstrip transmission line.

TRL CALIBRATION METHOD

Switch error removal

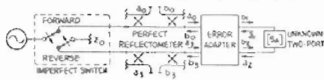

Forward

$$b_0 = S_{11} a_0 + S_{12} a_3$$

$$b_3 = S_{21} a_0 + S_{22} a_3$$

SOLVING THE ABOVE SET OF EQUATIONS YIELDS:

$$S_{11M} = \frac{b_0 - b'_0}{a_0} \frac{a_3}{d}$$

$$S_{22M} = \frac{b'_3 - b_3}{a_0} \frac{a'_0}{d}$$

$$d = 1 - \frac{a_3}{a_0} \frac{a'_0}{a_3}$$

Reverse

$$b'_0 = S_{11} a'_0 + S_{12} a'_3$$

$$b'_3 = S_{21} a'_0 + S_{22} a'_3$$

$$S_{21M} = \frac{b_3 - b'_3}{a_0} \frac{a_3}{d}$$

$$S_{12M} = \frac{b'_0 - b_0}{a_0} \frac{a_3}{d}$$

Imperfect switch is "ratioed out" using 6 measurements

6268

In order to remove the errors caused by the switch during the calibration phase, the s-parameters must be calculated using these equations. In effect the switch is "ratioed" out by the additional measurements.

TRL CALIBRATION METHOD

Non-zero length thru (7 mm)

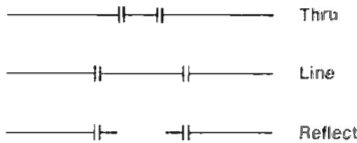

6269

If the thru connection can not be zero length, the TRL calibration method is still valid. This is important in environments where probes cannot be placed at the same reference plane or other physical constraints exist.

TRL CALIBRATION METHOD

Non-zero length thru

From the thru connection

$$(1) T_{MT} = T_X T_{AT} T_Y, \quad T_{AT} = \begin{bmatrix} e^{-\gamma \ell_T} & 0 \\ 0 & e^{\gamma \ell_T} \end{bmatrix}$$

From the line connection

$$(2) T_{MD} = T_X T_{AD} T_Y, \quad T_{AD} = \begin{bmatrix} e^{-\gamma \ell_D} & 0 \\ 0 & e^{\gamma \ell_D} \end{bmatrix}$$

From (1) & (2) we can solve for part of T_X .

$$(3) T_X [T_{AD} T_{AT}^{-1}] T_X^{-1} = [T_{MD} T_{MT}^{-1}]$$

$$\text{Where } T_{AD} T_{AT}^{-1} = \begin{bmatrix} e^{-(\gamma_D - \gamma_T)} & 0 \\ 0 & e^{-(\gamma_D + \gamma_T)} \end{bmatrix}$$

6270

With a non zero length thru the math follows the same approach as in the original TRL development. The only change is that the propagation constant is the difference between the thru and line connections.

TRL CALIBRATION METHOD

Non-zero length thru

We can solve for γl , e_{00} , e_{33} , $\frac{e_{10} e_{01}}{e_{11}}$ & $\frac{e_{23} e_{32}}{e_{22}}$

as before

where

$$\gamma l \triangleq \gamma (\ell_D - \ell_T)$$

6271

The same error terms can be solved for when using a non zero length thru, but the system reference impedance depends on the characteristic impedance of both lines.

TRL CALIBRATION METHOD

Non-zero length thru
TRL method

The reference plane is set at the center of the thru line.

If we want to move ref plane to the test ports we must know one of the following:

- (1) ℓ_D & ℓ_T , then $\gamma \ell_D = \frac{\ell_T}{\ell_D - \ell_T} \gamma \ell$
 (2) Γ_A of high refl.

6272

The reference plane is at the center of the thru line. If a different measurement reference plane is desired, the length and loss of the lines must be rotated correctly. This is done by knowing the physical length of the two lines or the reflection coefficient of the high reflect termination. When using airlines the reference plane rotation can also be accurately modeled if needed.

TRL CALIBRATION METHOD

Choice of line length

$$\ell \triangleq \ell_d - \ell_T = \frac{15}{f_1 + f_2} \text{ cm}$$

ℓ_d = length of delay line

ℓ_T = length of thru line (conveniently short)

f_1 & f_2 in GHz

$$\phi_{F1} = 180 - \phi_{F2} = \frac{180}{1 + f_2/f_1} \text{ deg}$$

$$\phi_F = 12\ell f \text{ deg}$$

Keep phase at $f_1 > 20^\circ$

Keep phase at $f_2 < 16^\circ$

6273

These formulas give the correct length for coax calibration lines. They are basically one quarter wavelength at the band center. They are the same lines required by the offset-load calibration method described earlier.

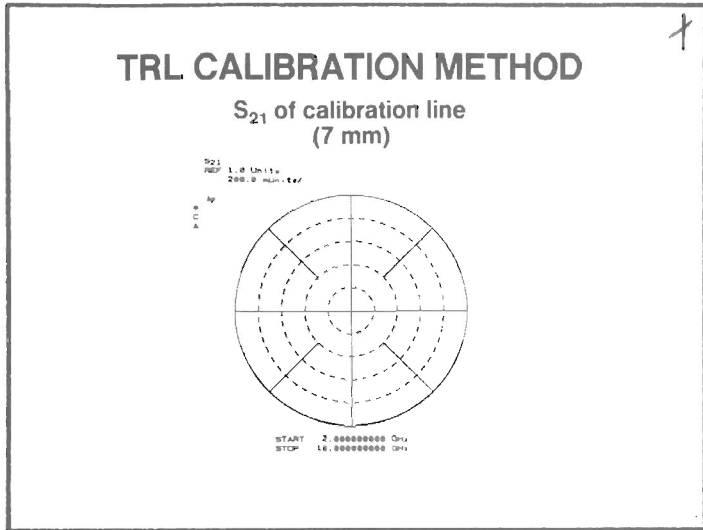

6274

This plot shows the phase shift of a 7mm long airline used from 2 to 18 GHz.

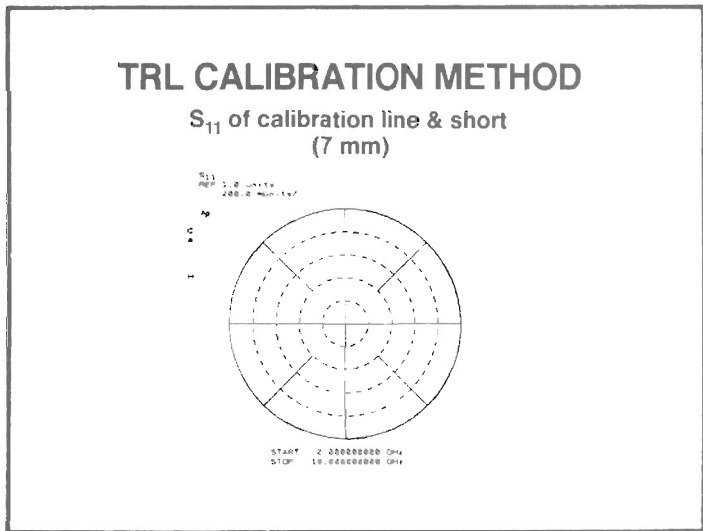

6275

This is the phase of the reflection coefficient of the same line terminated with a short. Note the phase margin at the start and stop frequencies.

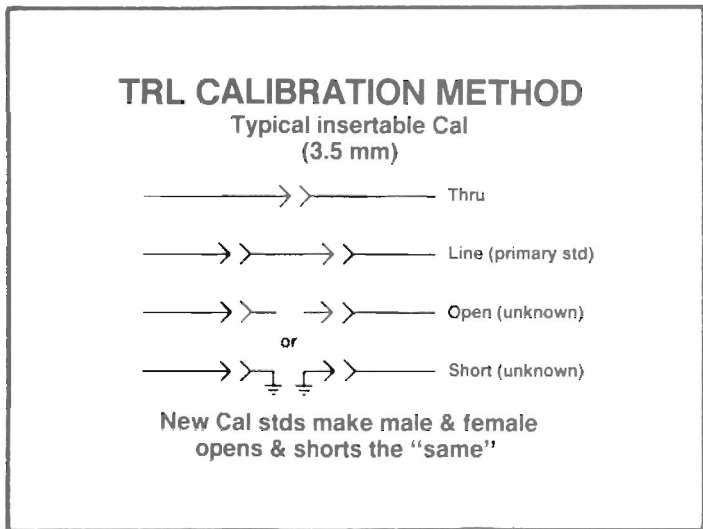

6276

The TRL calibration method can also be used with sexed connectors as long as the high reflects have the same reflection coefficient. The slotless and flush standards make this possible.

TRL CALIBRATION METHOD

Typical non-insertable Cal
(3.5 mm)

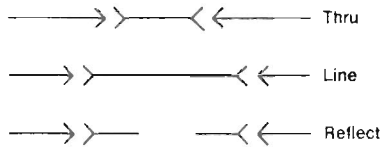

High reflects are not the same.

TRL can be used to calibrate the non-insertable case where the thru is used to connect the two ports. Note that the high reflects are now the same.

6277

TRL CALIBRATION METHOD

Typical Transitional Cal (3.5 mm to Type N)

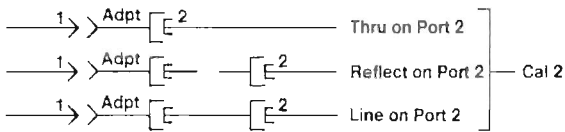
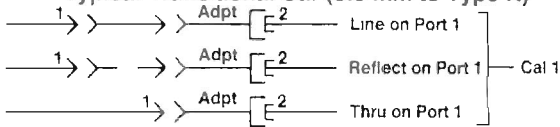

Combine Cal 1 & 2 and remove Adapter.

TRL can also be used to calibrate a system for transitional device measurements. Two separate TRL calibrations are done, one at each port, and then combined to remove the adapter.

6279

TRL CALIBRATION METHOD

10 cm airline term. with short
sliding load cal (7 mm)

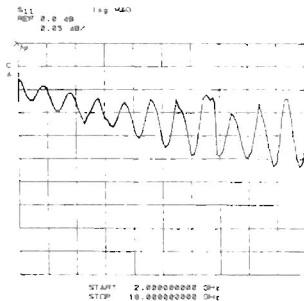

This measurement is the reflection coefficient of a 10 cm beadless airline terminated by a short. The calibration method used and open, short, and sliding load. The data is within specification by a factor of two.

6280

TRL CALIBRATION METHOD

10 cm airline term. with short
TRL cal (7 mm)

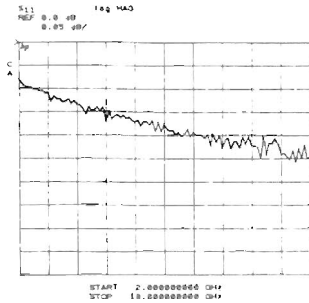

6281

The same measurement is made with the TRL calibration method and the errors are reduced by a factor of three.

TRL CALIBRATION METHOD

30 cm airline transmission measurement
 S_{21} & S_{12} (7 mm)

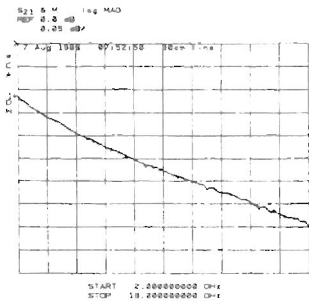

6282

This plot shows the transmission magnitude of a 30 cm beadless airline in both the forward and reverse directions. Note the excellent agreement and low ripple in this measurement.

TRL CALIBRATION METHOD

30 cm airline terminated with short
(7 mm)

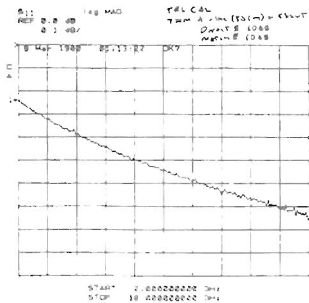

6283

The same 30 cm airline is terminated with a short and the reflection coefficient is measured. The ripple is caused by the port match and directivity errors which are both down about 60 dB.

TRL CALIBRATION METHOD

Time domain of previous freq. domain slide
Directivity & port match ≈ -60 dB

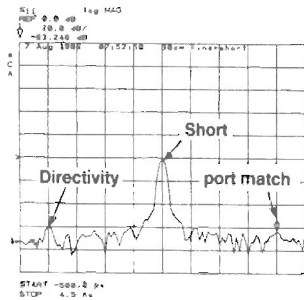

6284

The time domain response shows the directivity and port match errors compared to the short circuit response. Again the errors are close to 60 dB down.

TRL CALIBRATION METHOD

Repeatability of two different TRL Cals
measuring 50 dB term. (7 mm)

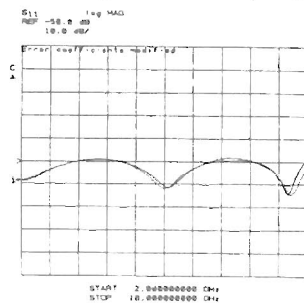

6285

The repeatability of two separate TRL calibrations shows agreement within 3 dB at 50 dB down which indicates that the repeatability is over 60 dB down.

TRL CALIBRATION METHOD

Transistor fixture
Modeled fixture vs TRL

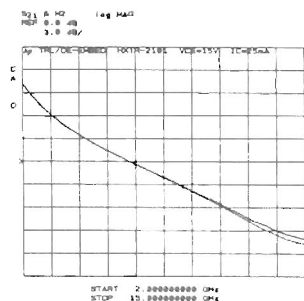

6286

TRL was used to calibrate a transistor fixture and the transistor measurements were compared to a carefully derived model of the same fixture. The results are very similar but show slight differences. The TRL calibration standard was a single 57 ohm transmission line.

TRL CALIBRATION METHOD

Transistor fixture
Modeled fixture vs TRL

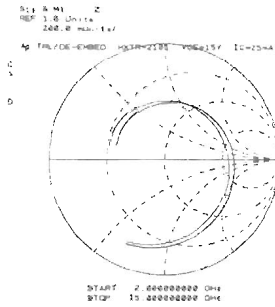

6287

The reflection measurements show a more dramatic difference. This difference occurred because the model was set to 50 ohms and the calibration airline was 57 ohms. Remember that the impedance after a TRL calibration is equal to the characteristic impedance of the calibration line standards. The difference between the two methods would be removed if a 50 ohm standard line was used.

ACCURACY OF ERROR CORRECTION

6288

The question most often asked, in accuracy enhancement discussions, is how accurate is the measurement of my device after I have calibrated. The question is very fair but but the answer is not easily stated. The next section outlines a process that provides a straight forward reply.

ACCURACY OF ERROR CORRECTION

Residual one-port errors during calibration

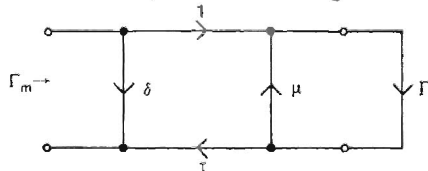

δ = Residual directivity after error corrections.
 τ = Tracking after error correction.
 μ = Residual match after error correction.

The residual errors after error correction can be represented by this flow graph. It is the same flow graph used for the raw uncorrected terms, the only difference is the their values are reduced.

ACCURACY OF ERROR CORRECTION

Residual Errors
Three known stds method

- $\delta = -(D_1\Gamma_2\Gamma_3 + D_2\Gamma_1\Gamma_3 + D_3\Gamma_1\Gamma_2)$
- $\tau = 1 + D_1(\Gamma_2 + \Gamma_3) + D_2(\Gamma_1 + \Gamma_3) + D_3(\Gamma_1 + \Gamma_2)$
- $\mu = -(D_1 + D_2 + D_3)/\tau$

Γ_1, Γ_2 & Γ_3 are the nominal values
of the three cal standards used

$$D_1 = \Delta_1 / [(\Gamma_1 - \Gamma_2)(\Gamma_1 - \Gamma_3)]$$

$$D_2 = \Delta_2 / [(\Gamma_2 - \Gamma_3)(\Gamma_2 - \Gamma_1)]$$

$$D_3 = \Delta_3 / [(\Gamma_3 - \Gamma_1)(\Gamma_3 - \Gamma_2)]$$

$\Delta_{1,2,3}$ = Deviation of stds from nominal

6290

If the nominal values of the calibration standards, used in the conventional three known standards calibration method, are known. And the deviation of these standards from the nominal are known, then these equations can be used to solve for the residual errors of the system.

ACCURACY OF ERROR CORRECTION

Sources of deviations from nominal
Three known stds method

1. Tolerances of mechanical stds & gauges
2. Measurement errors of electrical stds
3. Network analyzer errors (γ)
 - a. Dynamic noise
 - b. Noise
 - c. Drift
 - d. Connector repeatability
 - e. Cable stability

6291

The deviations can be caused not only by the standards themselves but also by the errors of the network analyzer. The errors in the standards are usually traced back to fundamental mechanical measurements which are typically very stable and accurate. These primary standards are usually air lines whose electrical characteristics are calculated from their mechanical dimensions and material properties.

ACCURACY OF ERROR CORRECTION

Simple residual error example
Three known stds

Load	$\Gamma_1 = 0$	$\Delta_1 = \Gamma_L$ (Refl of load)
Open	$\Gamma_2 = 1$	$\Delta_2 = j\beta$ (\emptyset error)
Short	$\Gamma_3 = -1$	$\Delta_3 = 0$ (assumed perfect)

$$D_1 = \Gamma_L, \quad D_2 = j\frac{\beta}{2}, \quad D_3 = 0$$

$$\delta = -\Gamma_L$$

$$\tau = 1 - j\frac{\beta}{2}$$

$$\mu = \Gamma_L - j\frac{\beta}{2}$$

6292

This simple case assumes that there are no network analyzer errors. And that the only standards errors are the return loss of the load and phase error of the open. The return loss of the load determines the system directivity and minimum port match error. The open phase error contributes additional degradation to the port match. Errors of the open also cause a phase error in the reflection tracking.

ACCURACY OF ERROR CORRECTION

Residual errors of stds
TRL method

Only systematic error is due to The Z'_0 of the thru & line.

The Γ' is measured relative to Z'_0

What is Γ relative to Z_0 (Defined Z of system)

$$\Gamma = \frac{\Gamma' - W}{1 - \Gamma'W}, \quad W = \frac{Z_0 - Z'_0}{Z_0 + Z'_0}$$

$$\Gamma = -W + \frac{(1 - W^2)\Gamma'}{1 - \Gamma'W}$$

6293

In the TRL calibration the only error caused by the standards is due to the characteristic impedance of the air line (if it is different than the desired system impedance). This impedance error causes the measured reflection coefficient to be normalized to the impedance of the calibration line.

ACCURACY OF ERROR CORRECTION

Residual Errors of stds
TRL method

- $\delta = -W$
- $\tau = 1 - W^2$
- $\mu = W$

$$W = \frac{Z_0 - Z'_0}{Z_0 + Z'_0}$$

$Z'_0 = Z$ of thru & line

$Z_0 =$ Defined Z of system (like 50Ω)

6294

The resultant residual error is due to the reflection coefficient between the desired system impedance and the calibration line impedance. Notice that the directivity and port match errors are the same magnitude and that the tracking error is very small. Of course, we must not forget that there are other system errors caused by the network analyzer which need to be included for a total analysis.

ACCURACY OF ERROR CORRECTION

Total uncertainty

$$\Gamma_M = \delta + \tau\Gamma + \mu\Gamma_2 + \gamma$$

δ, τ & μ include errors of stds & N.A.

γ is the errors of N.A. during meas.

The errors will be both systematic & random

Systematic errors added

Random errors RSS

6295

The total system one-port error can be represented by this equation. The errors due to the standards occur during the calibration step, but the errors of the network analyzer occur both during calibration and measurement. The systematic errors are added and the random error variances are combined in an RSS manner.

$$\Delta P = \frac{1}{8} + \frac{1}{(1-\epsilon)^2} + \frac{1}{2} \epsilon^2$$

ACCURACY OF ERROR CORRECTION

Comparison (7 mm) 18 GHz

Residual Errors	Open Short Load-fixed	Open Short Load-slide	Open Short Load-offset	TRL
Directivity δ	-40 dB	-52 dB	-60 dB	-60 dB
Match μ	-35 dB	-41 dB	-42 dB	-60 dB
Tracking τ	$\pm .1$ dB	$\pm .047$ dB	$\pm .035$ dB	± 0 dB

6296

This chart compares the relative accuracy of different calibration standards and calibration methods. The open, short, fixed load calibration is the most convenient but the least accurate. The standard sliding load calibration can be improved by using the offset-load calibration standard. The TRL calibration method provides the best accuracy and can be used in other transmission line environments as well.

ACCURACY OF ERROR CORRECTION

Two-port case

Same approach as one-port case

BUT

Math much more complex

Will not be covered at this time

6297

The two port error analysis follows the same procedure as the one port case but will not be discussed here. There has been a computer program written that calculates the errors for both one and two port devices and provides direct uncertainty calculations for the measured s-parameters of the device under test.

ACCURACY OF ERROR CORRECTION

Total S₂₁ Transmission Mag Uncertainty
System Using the HP8501B Test Set
and the HP8220B Cal Kit

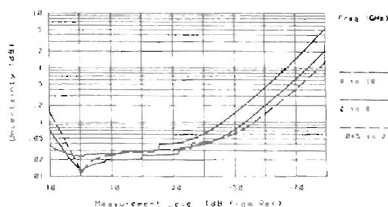

6298

This graph shows the transmission accuracy after error correction. The main error at high levels is due to compression. At low levels it is primarily due to noise.

ACCURACY OF ERROR CORRECTION

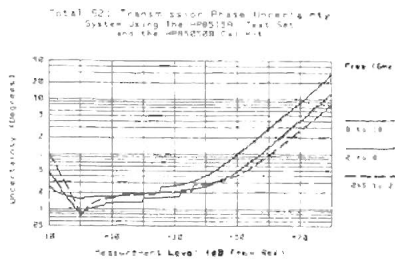

6299

The phase error of transmission closely follows the magnitude error.

ACCURACY OF ERROR CORRECTION

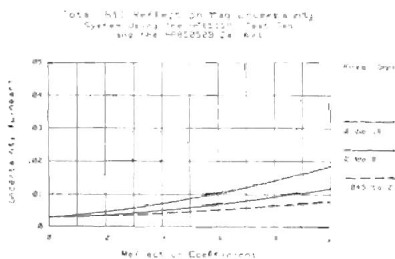

6300

This is the APC-7 reflection magnitude accuracy using the sliding load calibration. The main error at small reflection coefficients is due to the sliding load. At high levels the sliding load and the open circuit phase error are the primary contributors.

ACCURACY OF ERROR CORRECTION

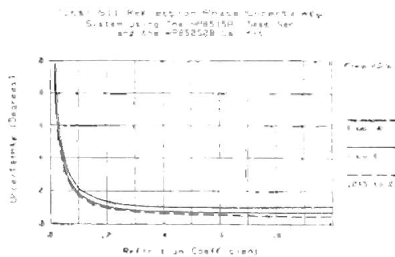

6301

The reflection phase error becomes very large for small reflections.

SUMMARY

- Calibration problems identified
- Improved standards introduced
- New calibration method (TRL) for simple and accurate measurements
- Method for calculating system performance

Calibration methods have greatly improved the past few years providing more accurate and easier to use techniques. It is hoped that this paper has outlined these improvements and provided insight to their power and usefulness.

6302

REFERENCES

- [1] Doug Rytting, "An Analysis of Vector Measurement Accuracy Enhancement Techniques," Hewlett-Packard, RF & MW Symposium, 1980
- [2] Glenn F. Engen and Cletus A. Hoer, "An Improved Technique for Calibrating the Dual Six-Port Automatic Network Analyzer," IEEE Transactions on Microwave Theory and Techniques, Vol. MTT-27, No. 12, pp 987-993, December 1979

